



Heating and Air Conditioning

TECHNICAL GUIDE

UP TO 98% AFUE MODULATING ECM RESIDENTIAL GAS FURNACES

MULTI-POSITION

MODELS: YP9C*C

NATURAL GAS

60 - 120 MBH INPUT



Due to continuous product improvement, specifications are subject to change without notice.

Visit us on the web at www.york.com for the most up-to-date technical information.

Additional rating information can be found at www.ahridirectory.org

WARRANTY SUMMARY

A 20-year limited warranty on heat exchangers in residential applications.

A 10-year warranty on the heat exchanger in commercial applications.

Standard 5-year limited Parts warranty.

Extended lifetime heat exchanger and 10-year limited parts warranty when product is registered online within 90 days of purchase for replacement or closing for new home construction.

See Limited Warranty certificate in Users Information Manual for details.

DESCRIPTION

These compact units employ induced combustion, reliable hot surface ignition and high heat transfer aluminized tubular heat exchangers. The units are factory shipped for installation in upflow or horizontal applications and may be converted for downflow applications.

These furnaces are designed for residential installation in a basement, closet, alcove, attic, recreation room or garage and are also ideal for commercial applications. All units are factory assembled, wired and tested to assure safe dependable and economical installation and operation.

These units are Category IV listed and may be vented either through side wall or roof applications using approved plastic combustion air and vent piping.

FEATURES

- Modulating heating operation includes:
 - Modulating gas valve, inducer and circulating blower
 - Modulating operation from 100% to 35% input in 100 increments with nearly constant temperature rise.
- Easily applied in upflow, horizontal left or right, or downflow installation with minimal conversion necessary.
- Compact, easy to install, ideal height 33" tall cabinet.
- ECM variable speed drive for cooling SEER enhancement, improved comfort with optional airflow delay profiles, and continuous fan options for IAQ performance.
- Easy access to controls to connect power/control wiring.
- Built-in, high level self diagnostics with fault code display.
- Low unit amp requirement for easy replacement application.
- All models are convertible to use propane (LP) gas.
- Electronic Hot Surface Ignition saves fuel cost with increased dependability and reliability.
- 100% shut off main gas valve for extra safety.
- 24V, 40 VA control transformer and blower relay supplied for add-on cooling.
- Airflow leakage less than 1% of nominal airflow for ductblaster conditions.
- Solid removable bottom panel allows easy conversion.
- Hi-tech tubular aluminized steel primary heat exchanger with stainless steel tube/aluminum fin secondary heat exchanger for outstanding efficiency.
- No knockouts to deal with, making installation easier.
- Movable duct connector flanges for application flexibility.
- Quiet inducer operation, burner, and blower operation.
- Inducer rotates for easy conversion of venting options.
- Fully supported blower assembly for easy access and removal of blower.
- External air filters used for maximum flexibility in meeting customers IAQ needs.
- Insulated blower compartment for thermal and acoustic performance.
- 1/4 turn knobs provided for easy independent door removal.
- Internal condensate trap design (patent pending) provides condensate management options and is self priming to prevent nuisance problems.
- These models may be connected as part of a communicating control system using a 4-wire connection bus.
- The York YP9C modulating ECM furnace is part of a "Hybrid Comfort System" when paired with a York Heat Pump.

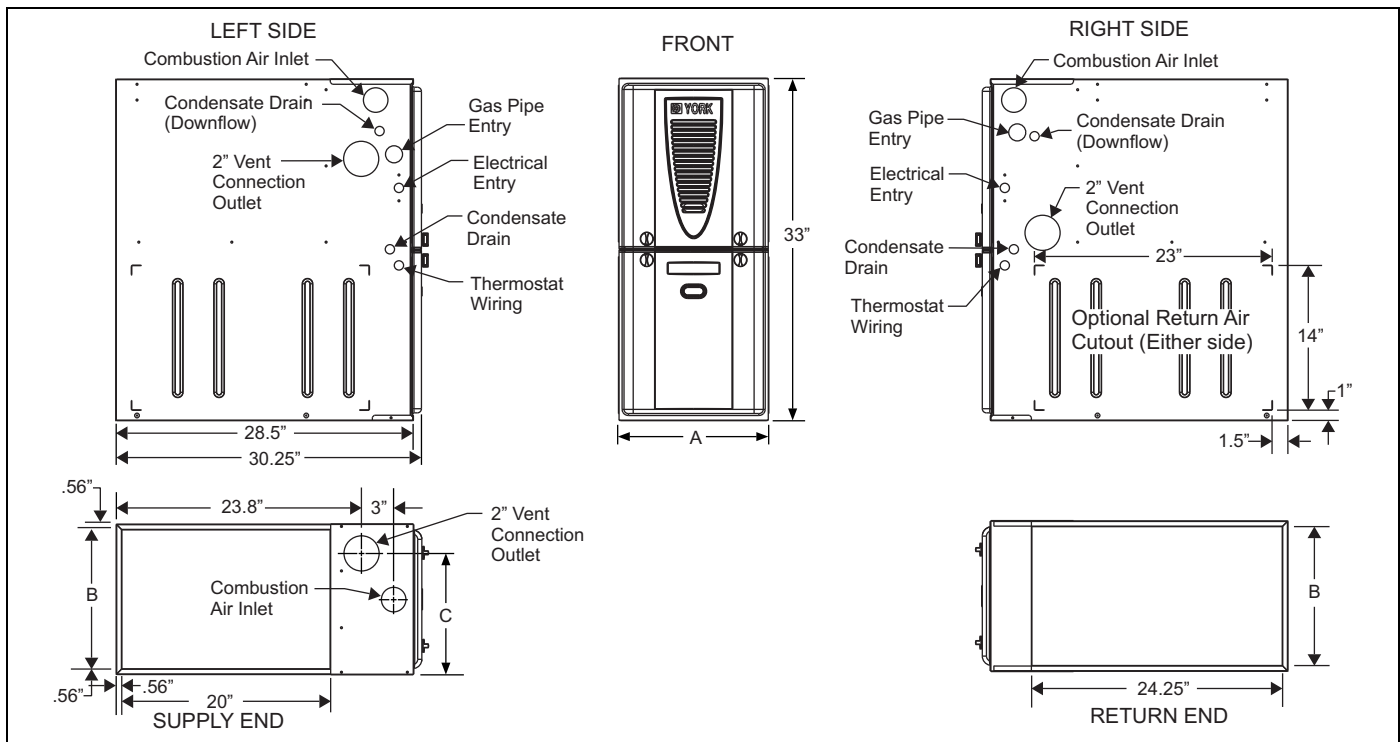

Cabinet and Duct Dimensions

Models	Nominal CFM	Cabinet Size	Cabinet Dimensions (Inches)		
			A	B	C
YP9C060B12MP12C	1200	B	17 1/2	16 3/8	13 1/4
YP9C080B12MP12C	1200	B	17 1/2	16 3/8	14 3/4
YP9C080C16MP12C	1600	C	21	19 7/8	16 1/2
YP9C100C16MP12C	1600	C	21	19 7/8	18 1/4
YP9C100C20MP12C	2000	C	21	19 7/8	18 1/4
YP9C120D20MP12C	2000	D	24 1/2	23 3/8	21 3/4

Ratings & Physical / Electrical Data

Models	Input Max/Min	Output Max/Min	AFUE	Nominal Airflow	Total Unit Amps	Air Temp. Rise Max Input	Air Temp. Rise Min Input
	MBH	MBH				%	CFM
YP9C060B12MP12C	60/21	58/20	97.5	1200	7.0	40-70	20-50
YP9C080B12MP12C	80/28	77/27	97.5	1200	7.5	40-70	20-50
YP9C080C16MP12C	80/28	78/27	97.7	1600	10.0	40-70	20-50
YP9C100C16MP12C	100/35	97/34	97.7	1600	10.0	40-70	20-50
YP9C100C20MP12C	100/35	97/34	97.7	2000	12.0	45-75	25-55
YP9C120D20MP12C	120/42	116/40	98.0	2000	12.0	45-75	25-55
Models	Max. Outlet Air Temp	Blower		Blower Wheel Size	Max Over-Current Protect	Min. wire Size (awg) @ 75 ft one way	Approximate Operating Weights
	°F	HP	Amps				Lbs
YP9C060B12MP12C	170	1/2	4.8	11 x 8	15	14	113
YP9C080B12MP12C	175	1/2	4.8	11 x 8	15	14	119
YP9C080C16MP12C	175	3/4	7.5	11 x 10	15	14	134
YP9C100C16MP12C	175	3/4	7.5	11 x 10	15	14	140
YP9C100C20MP12C	180	1	14.5	11 x 11	20	12	143
YP9C120D20MP12C	180	1	14.5	11 x 11	20	12	152

Annual Fuel Utilization Efficiency (AFUE) numbers are determined in accordance with DOE Test procedures. Wire size and over current protection must comply with the National Electrical Code (NFPA-70-latest edition) and all local codes. The furnace shall be installed so that the electrical components are protected from water.

FILTER PERFORMANCE

The airflow capacity data published in the "Blower Performance" table represents blower performance WITHOUT filters.

All applications of these furnaces require the use of field installed air filters. All filter media and mounting hardware or provisions must be field installed external to the furnace cabinet. DO NOT attempt to install any filters inside the furnace.

NOTE: Single side return above 1800 CFM is approved as long as the filter velocity does not exceed filter manufacturer's recommendation and a transition is used to allow use of a 20 x 25 filter.

Recommended Filter Sizes

CFM	Cabinet Size	Side (in)	Bottom (in)
1200	B	16 x 25	16 x 25
1600	C	16 x 25	20 x 25
2000	C	(2) 16 x 25	20 x 25
2000	D	(2) 16 x 25	22 x 25

NOTES:

- Air velocity through throwaway type filters may not exceed 300 feet per minute (91.4 m/min). All velocities over this require the use of high velocity filters.
- Do not exceed 1800 CFM using a single side return and a 16x25 filter. For CFM greater than 1800, you may use two side returns or one side and the bottom or one return with a transition to allow use of a 20x25 filter.

Unit Clearances to Combustibles

Application	Upflow	Downflow	Horizontal
Top	1"	0"	0"
Vent	0"	0"	0"
Rear	0"	0"	0"
Side	0"	0"	1"
Front ¹	0"	0"	0"
Floor	Combustible	Combustible ²	Combustible
Closet	Yes	Yes	Yes
Line Contact	No	No	Yes

- Line contact only permitted between lines formed by the intersection of the rear panel and side panel (top in horizontal position) of the furnace jacket and building joists, studs or framing.
- For combustible floors only when used with special sub-base. All furnaces approved for alcove and attic installation.

ACCESSORIES

Propane (LP) Conversion Kit -

1NP0681 - All Models

This accessory conversion kit may be used to convert natural gas (N) units for propane (LP) operation.

Do not use Conversion Kit S1-1NP0680 with these models, as the control/gas valve combination have been updated, and that kit S1-1NP0680 will not function correctly with these models.

Concentric Vent Termination -

S1-1CT0302 (2")

S1-1CT0303 (3")

For use through rooftop, sidewall. Allows combustion air to enter and exhaust to exit through single common hole. Eliminates unsightly elbows for a cleaner installation.

Sidewall Vent Termination Kit -

S1-1HT0901 (3")

S1-1HT0902 (2")

For use on sidewall, two-pipe installations only. Provide a more attractive termination for locations where the terminal is visible on the side of the home.

Condensate Neutralizer Kit -

1NK0301

Neutralizer cartridge has a 1/2" plastic tube fittings for installation in the drain line. Calcium carbonate refill media is also available from the Source 1 Parts (p/n 026-30228-000).

Side Return Filter Racks -

1SR0200 - All Models

1SR0402 - All Models

1SF0101 - All Models

Bottom Return Filter Racks -

1BR0517 or 1BR0617 - For 17-1/2" cabinets

1BR0521 or 1BR0621 - For 21" cabinets

1BR0524 or 1BR0624 - For 24-1/2" cabinets

1BR05xx series are galvanized steel filter racks. 1BR06xx are pre-painted steel filter racks to match the appearance of the furnace cabinet.

Combustible Floor Base Kit -

For installation of these furnaces in downflow applications directly onto combustible flooring material, These kits are required to prevent potential overheating situations. These kits are also required in any applications where the furnace is installed in a downflow configuration without an evaporator coil, where the combustible floor base kit provides access for combustible airflow.

1CB0517 - For 17-1/2" cabinets

1CB0521 - For 21" cabinets

1CB0524 - For 24-1/2" cabinets

High Altitude - No high altitude kits are required.

Thermostats - Compatible thermostat controls are available through accessory sourcing. For optimum performance and installation, refer to the UPGNET "Low Voltage Wiring Diagram" document to select and apply controls.

Blower Performance CFM - Any Position

High / Low Speed Cooling CFM					
060B12°C		080B12°C		Jumper Settings	
Hi Cool	Lo Cool	Hi Cool	Lo Cool	COOL Jumper	ADJ Jumper
1305	850	1290	840	H	B
1100	715	1090	710	MH	B
1065	690	1015	660	H	A
1000	650	1000	650	MH	A
960	625	960	625	H	C
760	495	760	495	ML	B
900	585	900	585	MH	C
660	430	660	430	L	B
690	450	680	445	ML	A
600	400	600	400	L	A
620	400	620	400	ML	C
550	400	540	400	L	C
High / Low Speed Cooling CFM					
080C16°C		100C16°C		Jumper Settings	
Hi Cool	Lo Cool	Hi Cool	Lo Cool	COOL Jumper	ADJ Jumper
1670	1085	1655	1075	H	B
1295	840	1275	820	MH	B
1385	900	1345	875	H	A
1175	765	1160	755	MH	A
1245	810	1210	785	H	C
995	645	1000	650	ML	B
1055	685	1045	680	MH	C
935	605	955	620	L	B
905	590	910	590	ML	A
850	550	870	565	L	A
815	530	815	530	ML	C
765	500	785	510	L	C
High / Low Speed Cooling CFM					
100C20°C		120D20°C		Jumper Settings	
Hi Cool	Lo Cool	Hi Cool	Lo Cool	COOL Jumper	ADJ Jumper
2215	1440	2180	1415	H	B
1765	1145	1760	1140	MH	B
1820	1180	1800	1170	H	A
1605	1040	1595	1035	MH	A
1635	1060	1620	1050	H	C
1270	825	1255	815	ML	B
1445	940	1435	935	MH	C
1055	685	1050	680	L	B
1155	750	1160	755	ML	A
960	620	960	615	L	A
1040	675	1035	670	ML	C
860	560	840	545	L	C

All CFM's are shown at 0.5" w.c. external static pressure. These units have variable speed motors that automatically adjust to provide constant CFM from 0.0" to 0.6" w.c. static pressure. From 0.6" to 1.0" static pressure, CFM is reduced by 2% per 0.1" increase in static. Operation on duct systems with greater than 1.0" w.c. external static pressure is not recommended.

NOTE: At some settings, LOW COOL airflow may be lower than what is required to operate an airflow switch on certain models of electronic air cleaners. Consult the instructions for the electronic air cleaner for further details.